

A Fast Matching Algorithm

Algorithm 52 Bimatch-Hopcroft-Karp(G)

```
1:  $M \leftarrow \emptyset$ 
2: repeat
3:   let  $\mathcal{P} = \{P_1, \dots, P_k\}$  be maximal set of
4:   vertex-disjoint, shortest augmenting path w.r.t.  $M$ .
5:    $M \leftarrow M \oplus (P_1 \cup \dots \cup P_k)$ 
6: until  $\mathcal{P} = \emptyset$ 
7: return  $M$ 
```

We call one iteration of the repeat-loop a **phase** of the algorithm.

Analysis Hopcroft-Karp

Lemma 6

Given a matching M and a matching M^* with $|M^*| - |M| \geq 0$.
There exist $|M^*| - |M|$ *vertex-disjoint* augmenting path w.r.t. M .

Analysis Hopcroft-Karp

Lemma 6

Given a matching M and a matching M^* with $|M^*| - |M| \geq 0$.
There exist $|M^*| - |M|$ *vertex-disjoint* augmenting path w.r.t. M .

Proof:

- ▶ Similar to the proof that a matching is optimal iff it does not contain an augmenting path.

Analysis Hopcroft-Karp

Lemma 6

Given a matching M and a matching M^* with $|M^*| - |M| \geq 0$.
There exist $|M^*| - |M|$ *vertex-disjoint* augmenting path w.r.t. M .

Proof:

- ▶ Similar to the proof that a matching is optimal iff it does not contain an augmenting path.
- ▶ Consider the graph $G = (V, M \oplus M^*)$, and mark edges in this graph blue if they are in M and red if they are in M^* .

Analysis Hopcroft-Karp

Lemma 6

Given a matching M and a matching M^* with $|M^*| - |M| \geq 0$.
There exist $|M^*| - |M|$ *vertex-disjoint* augmenting path w.r.t. M .

Proof:

- ▶ Similar to the proof that a matching is optimal iff it does not contain an augmenting path.
- ▶ Consider the graph $G = (V, M \oplus M^*)$, and mark edges in this graph blue if they are in M and red if they are in M^* .
- ▶ The connected components of G are cycles and paths.

Analysis Hopcroft-Karp

Lemma 6

Given a matching M and a matching M^* with $|M^*| - |M| \geq 0$.
There exist $|M^*| - |M|$ *vertex-disjoint* augmenting path w.r.t. M .

Proof:

- ▶ Similar to the proof that a matching is optimal iff it does not contain an augmenting path.
- ▶ Consider the graph $G = (V, M \oplus M^*)$, and mark edges in this graph blue if they are in M and red if they are in M^* .
- ▶ The connected components of G are cycles and paths.
- ▶ The graph contains $k \stackrel{\text{def}}{=} |M^*| - |M|$ more red edges than blue edges.

Analysis Hopcroft-Karp

Lemma 6

Given a matching M and a matching M^* with $|M^*| - |M| \geq 0$.
There exist $|M^*| - |M|$ *vertex-disjoint* augmenting path w.r.t. M .

Proof:

- ▶ Similar to the proof that a matching is optimal iff it does not contain an augmenting path.
- ▶ Consider the graph $G = (V, M \oplus M^*)$, and mark edges in this graph blue if they are in M and red if they are in M^* .
- ▶ The connected components of G are cycles and paths.
- ▶ The graph contains $k \stackrel{\text{def}}{=} |M^*| - |M|$ more red edges than blue edges.
- ▶ Hence, there are at least k components that form a path starting and ending with a red edge. These are augmenting paths w.r.t. M .

Analysis Hopcroft-Karp

- ▶ Let P_1, \dots, P_k be a maximal collection of vertex-disjoint, shortest augmenting paths w.r.t. M (let $\ell = |P_i|$).

Analysis Hopcroft-Karp

- ▶ Let P_1, \dots, P_k be a maximal collection of vertex-disjoint, shortest augmenting paths w.r.t. M (let $\ell = |P_i|$).
- ▶ $M' \stackrel{\text{def}}{=} M \oplus (P_1 \cup \dots \cup P_k) = M \oplus P_1 \oplus \dots \oplus P_k$.

Analysis Hopcroft-Karp

- ▶ Let P_1, \dots, P_k be a maximal collection of vertex-disjoint, shortest augmenting paths w.r.t. M (let $\ell = |P_i|$).
- ▶ $M' \stackrel{\text{def}}{=} M \oplus (P_1 \cup \dots \cup P_k) = M \oplus P_1 \oplus \dots \oplus P_k$.
- ▶ Let P be an augmenting path in M' .

Analysis Hopcroft-Karp

- ▶ Let P_1, \dots, P_k be a maximal collection of vertex-disjoint, shortest augmenting paths w.r.t. M (let $\ell = |P_i|$).
- ▶ $M' \stackrel{\text{def}}{=} M \oplus (P_1 \cup \dots \cup P_k) = M \oplus P_1 \oplus \dots \oplus P_k$.
- ▶ Let P be an augmenting path in M' .

Lemma 7

The set $A \stackrel{\text{def}}{=} M \oplus (M' \oplus P) = (P_1 \cup \dots \cup P_k) \oplus P$ contains at least $(k+1)\ell$ edges.

Analysis Hopcroft-Karp

Proof.

- ▶ The set describes exactly the symmetric difference between matchings M and $M' \oplus P$.

Analysis Hopcroft-Karp

Proof.

- ▶ The set describes exactly the symmetric difference between matchings M and $M' \oplus P$.
- ▶ Hence, the set contains at least $k + 1$ vertex-disjoint augmenting paths w.r.t. M as $|M'| = |M| + k + 1$.

Analysis Hopcroft-Karp

Proof.

- ▶ The set describes exactly the symmetric difference between matchings M and $M' \oplus P$.
- ▶ Hence, the set contains at least $k + 1$ vertex-disjoint augmenting paths w.r.t. M as $|M'| = |M| + k + 1$.
- ▶ Each of these paths is of length at least ℓ .

Analysis Hopcroft-Karp

Lemma 8

P is of length at least $\ell + 1$. This shows that the length of a shortest augmenting path increases between two phases of the Hopcroft-Karp algorithm.

Analysis Hopcroft-Karp

Lemma 8

P is of length at least $\ell + 1$. This shows that the length of a shortest augmenting path increases between two phases of the Hopcroft-Karp algorithm.

Proof.

- ▶ If P does not intersect any of the P_1, \dots, P_k , this follows from the maximality of the set $\{P_1, \dots, P_k\}$.

Analysis Hopcroft-Karp

Lemma 8

P is of length at least $\ell + 1$. This shows that the length of a shortest augmenting path increases between two phases of the Hopcroft-Karp algorithm.

Proof.

- ▶ If P does not intersect any of the P_1, \dots, P_k , this follows from the maximality of the set $\{P_1, \dots, P_k\}$.
- ▶ Otherwise, at least one edge from P coincides with an edge from paths $\{P_1, \dots, P_k\}$.

Analysis Hopcroft-Karp

Lemma 8

P is of length at least $\ell + 1$. This shows that the length of a shortest augmenting path increases between two phases of the Hopcroft-Karp algorithm.

Proof.

- ▶ If P does not intersect any of the P_1, \dots, P_k , this follows from the maximality of the set $\{P_1, \dots, P_k\}$.
- ▶ Otherwise, at least one edge from P coincides with an edge from paths $\{P_1, \dots, P_k\}$.
- ▶ This edge is not contained in A .

Analysis Hopcroft-Karp

Lemma 8

P is of length at least $\ell + 1$. This shows that the length of a shortest augmenting path increases between two phases of the Hopcroft-Karp algorithm.

Proof.

- ▶ If P does not intersect any of the P_1, \dots, P_k , this follows from the maximality of the set $\{P_1, \dots, P_k\}$.
- ▶ Otherwise, at least one edge from P coincides with an edge from paths $\{P_1, \dots, P_k\}$.
- ▶ This edge is not contained in A .
- ▶ Hence, $|A| \leq k\ell + |P| - 1$.

Analysis Hopcroft-Karp

Lemma 8

P is of length at least $\ell + 1$. This shows that the length of a shortest augmenting path increases between two phases of the Hopcroft-Karp algorithm.

Proof.

- ▶ If P does not intersect any of the P_1, \dots, P_k , this follows from the maximality of the set $\{P_1, \dots, P_k\}$.
- ▶ Otherwise, at least one edge from P coincides with an edge from paths $\{P_1, \dots, P_k\}$.
- ▶ This edge is not contained in A .
- ▶ Hence, $|A| \leq k\ell + |P| - 1$.
- ▶ The lower bound on $|A|$ gives $(k + 1)\ell \leq |A| \leq k\ell + |P| - 1$, and hence $|P| \geq \ell + 1$.

Analysis Hopcroft-Karp

If the shortest augmenting path w.r.t. a matching M has ℓ edges then the cardinality of the maximum matching is of size at most $|M| + \frac{|V|}{\ell+1}$.

Analysis Hopcroft-Karp

If the shortest augmenting path w.r.t. a matching M has ℓ edges then the cardinality of the maximum matching is of size at most $|M| + \frac{|V|}{\ell+1}$.

Proof.

The symmetric difference between M and M^* contains $|M^*| - |M|$ vertex-disjoint augmenting paths. Each of these paths contains at least $\ell + 1$ vertices. Hence, there can be at most $\frac{|V|}{\ell+1}$ of them.

Lemma 9

The Hopcroft-Karp algorithm requires at most $2\sqrt{|V|}$ phases.

Analysis Hopcroft-Karp

Lemma 9

The Hopcroft-Karp algorithm requires at most $2\sqrt{|V|}$ phases.

Proof.

- ▶ After iteration $\lfloor \sqrt{|V|} \rfloor$ the length of a shortest augmenting path must be at least $\lfloor \sqrt{|V|} \rfloor + 1 \geq \sqrt{|V|}$.
- ▶ Hence, there can be at most $|V| / (\sqrt{|V|} + 1) \leq \sqrt{|V|}$ additional augmentations.

Analysis Hopcroft-Karp

Lemma 10

One phase of the Hopcroft-Karp algorithm can be implemented in time $\mathcal{O}(m)$.

construct a “level graph” G' :

- ▶ construct Level 0 that includes all free vertices on left side L
- ▶ construct Level 1 containing all neighbors of Level 0
- ▶ construct Level 2 containing **matching** neighbors of Level 1
- ▶ construct Level 3 containing all neighbors of Level 2
- ▶ ...
- ▶ stop when a level (apart from Level 0) contains a free vertex

can be done in time $\mathcal{O}(m)$ by a modified BFS

Analysis Hopcroft-Karp

- ▶ a shortest augmenting path **must** go from Level 0 to the last layer constructed
- ▶ it can only use edges between layers
- ▶ construct a maximal set of vertex disjoint augmenting path connecting the layers
- ▶ for this, go forward until you either reach a free vertex or you reach a “dead end” v
- ▶ if you reach a free vertex delete the augmenting path and all incident edges from the graph
- ▶ if you reach a dead end backtrack and delete v together with its incident edges

Analysis Hopcroft-Karp

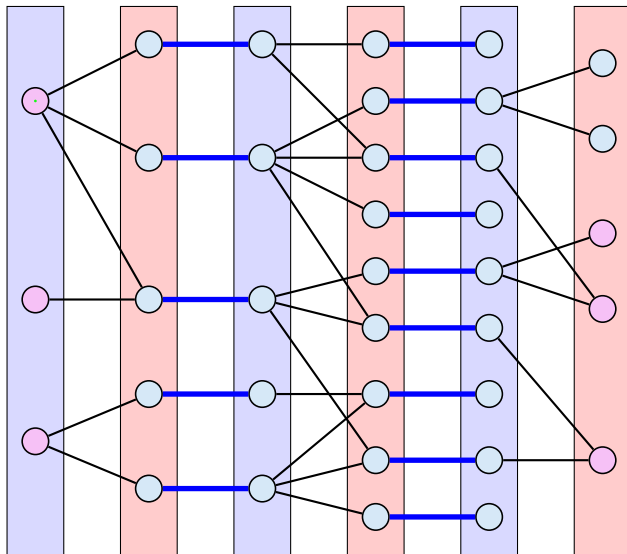

Analysis Hopcroft-Karp

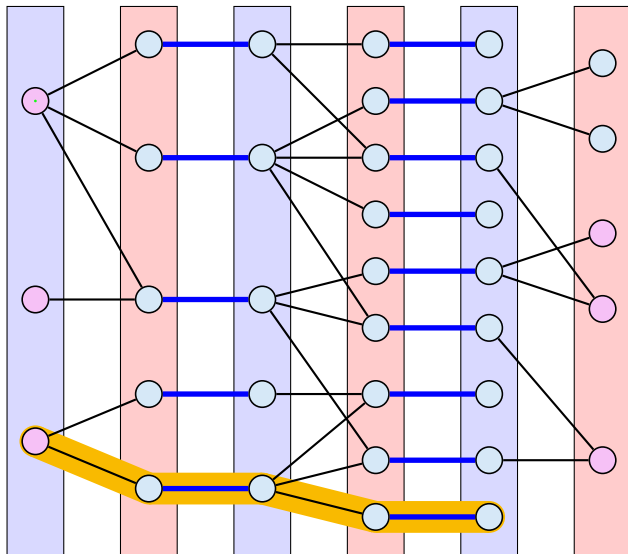

Analysis Hopcroft-Karp

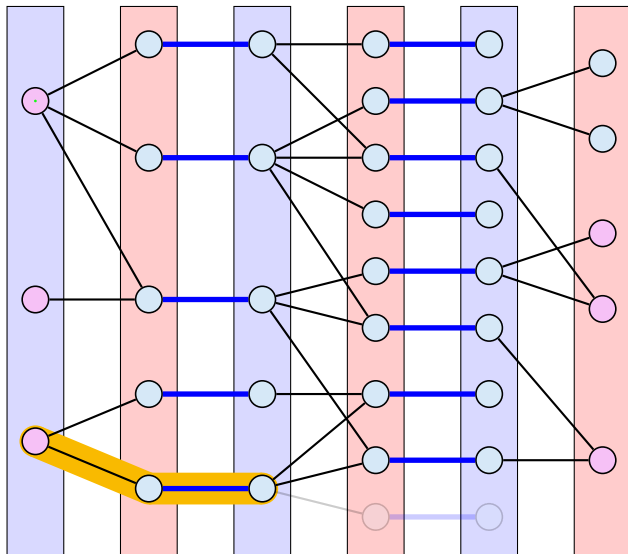

Analysis Hopcroft-Karp

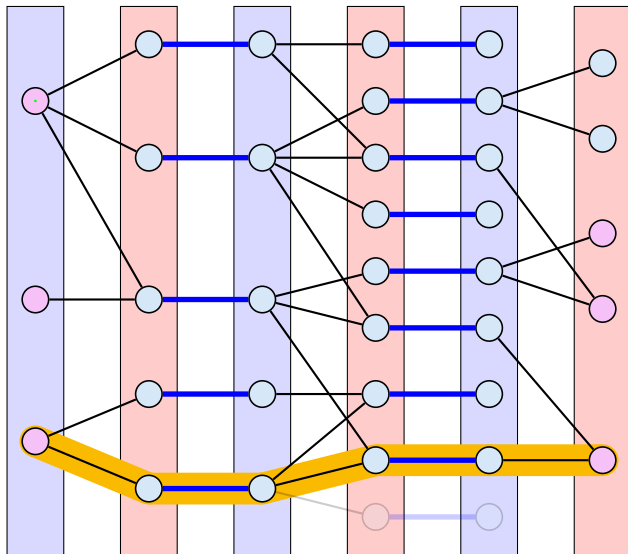

Analysis Hopcroft-Karp

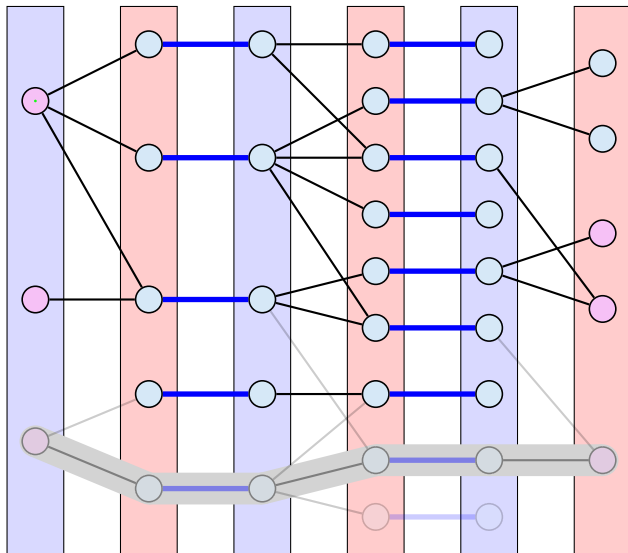

Analysis Hopcroft-Karp

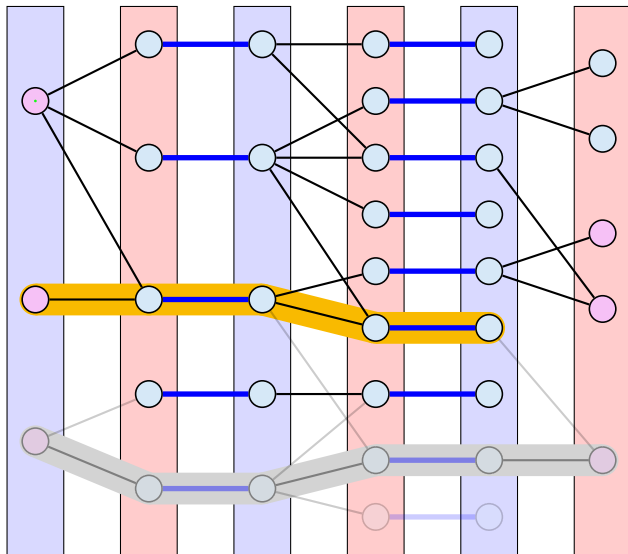

Analysis Hopcroft-Karp

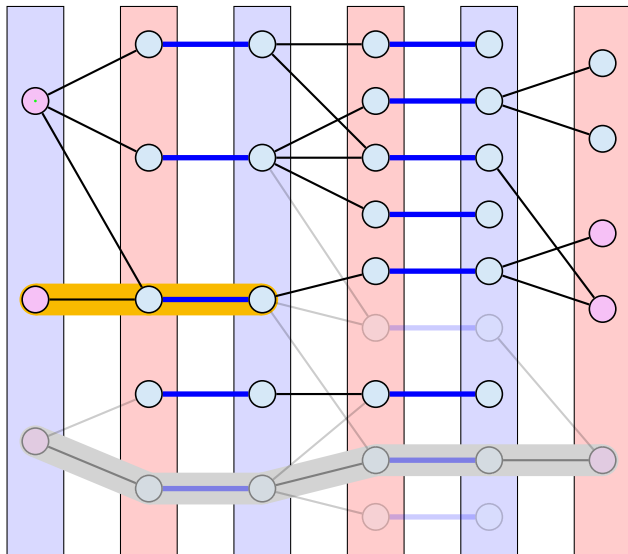

Analysis Hopcroft-Karp

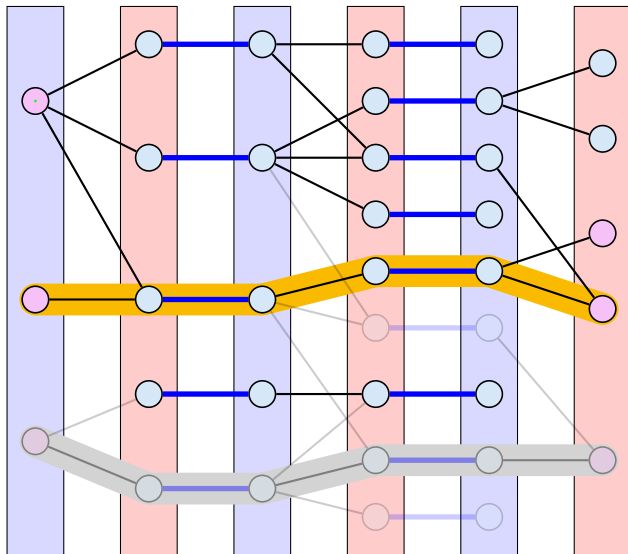

Analysis Hopcroft-Karp

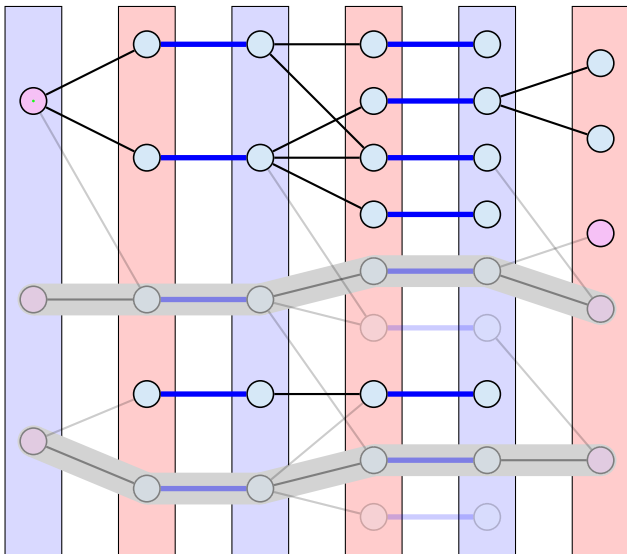

Analysis Hopcroft-Karp

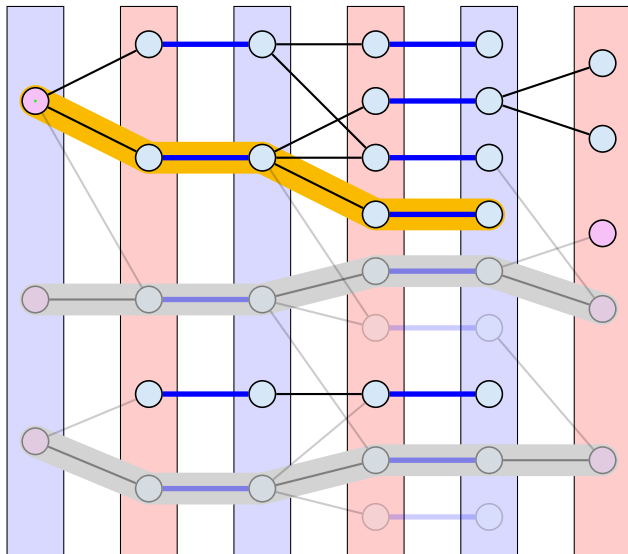

Analysis Hopcroft-Karp

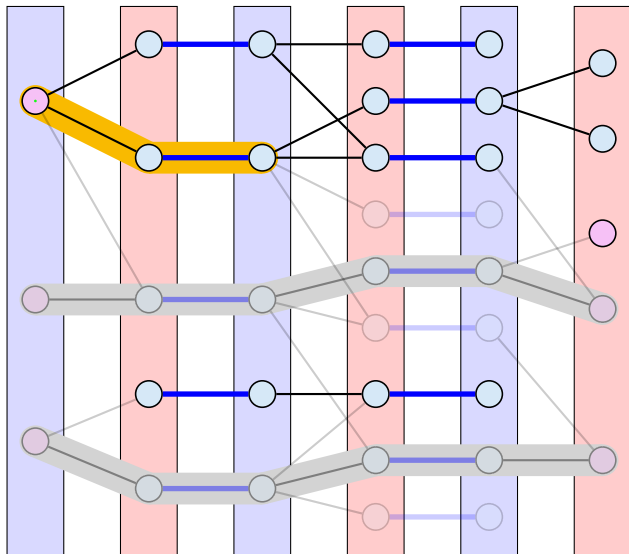

Analysis Hopcroft-Karp

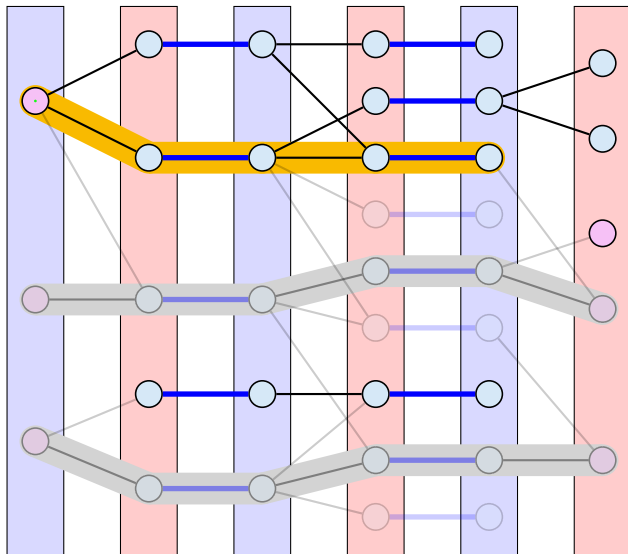

Analysis Hopcroft-Karp

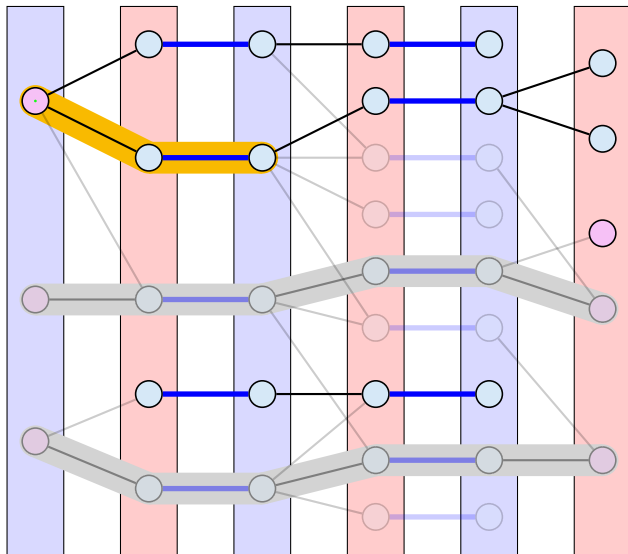

Analysis Hopcroft-Karp

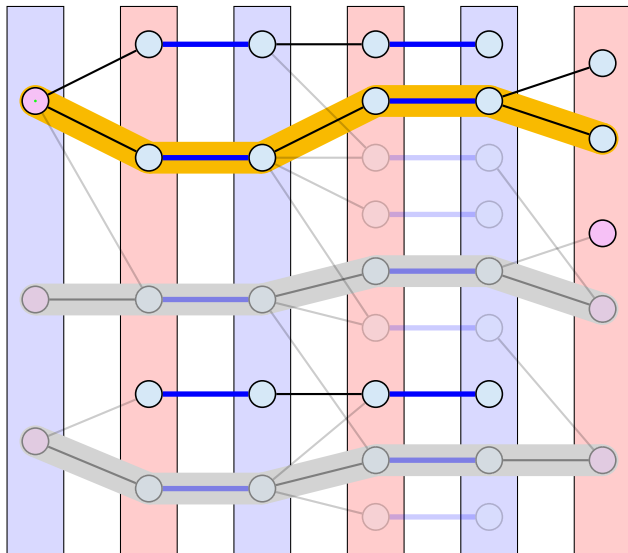

Analysis Hopcroft-Karp

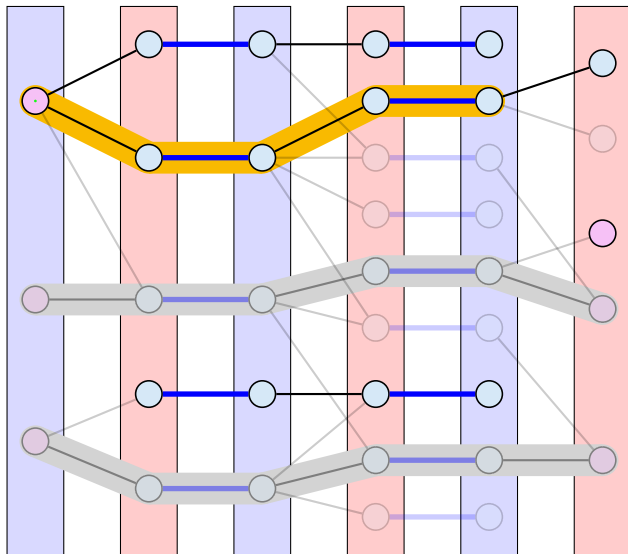

Analysis Hopcroft-Karp

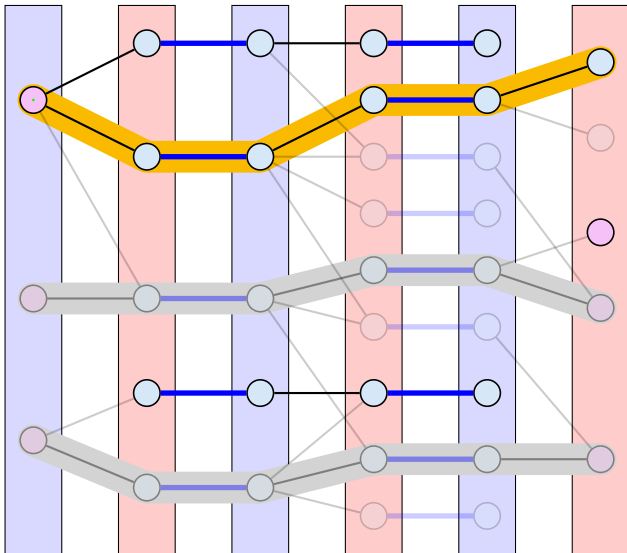

Analysis Hopcroft-Karp

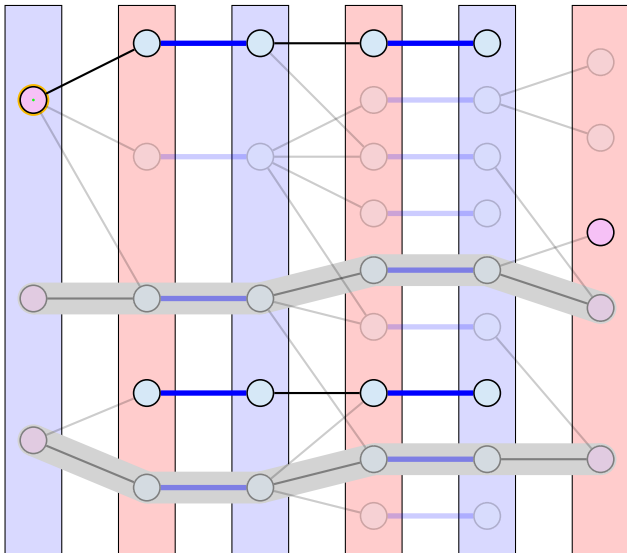

Analysis Hopcroft-Karp

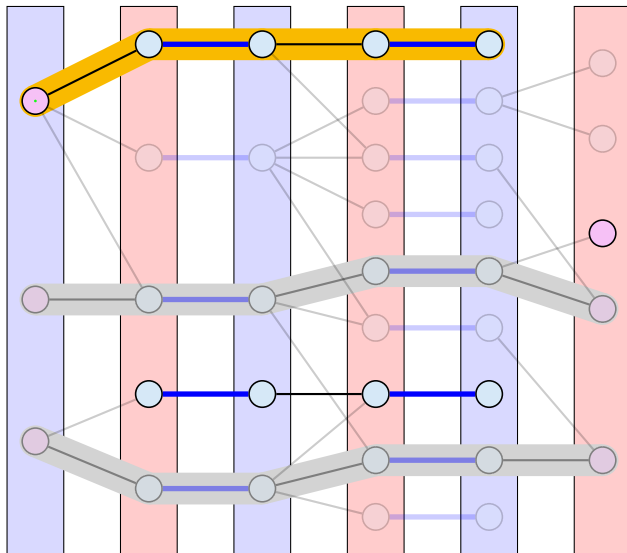

Analysis Hopcroft-Karp

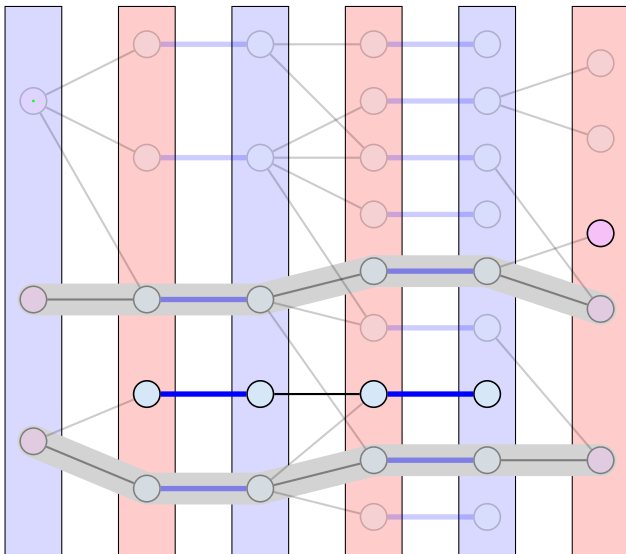

Analysis Hopcroft-Karp

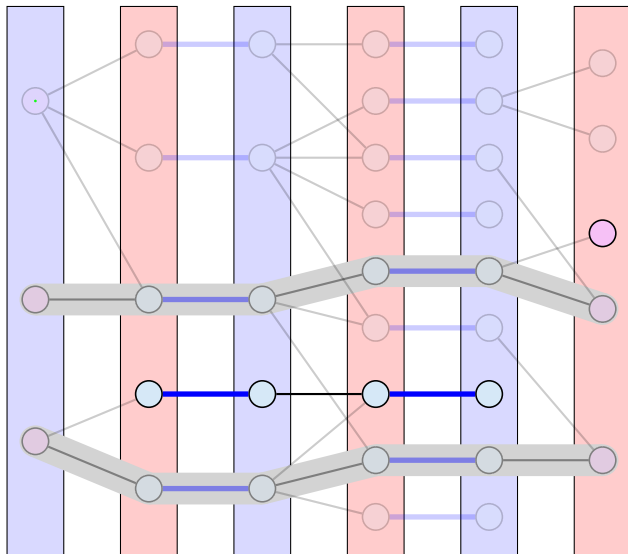

Analysis: Shortest Augmenting Path for Flows

cost for searches during a phase is $\mathcal{O}(mn)$

- ▶ a search (successful or unsuccessful) takes time $\mathcal{O}(n)$
- ▶ a search deletes at least one edge from the level graph

there are at most n phases

Time: $\mathcal{O}(mn^2)$.

Analysis for Unit-capacity Simple Networks

cost for searches during a phase is $\mathcal{O}(m)$

- ▶ an edge/vertex is traversed at most twice

need at most $\mathcal{O}(\sqrt{n})$ phases

- ▶ after \sqrt{n} phases there is a cut of size at most \sqrt{n} in the residual graph
- ▶ hence at most \sqrt{n} additional augmentations required

Time: $\mathcal{O}(m\sqrt{n})$.